

Model No : CA31D04.11



Features:

- Ultra-slim 4×5mm profile for discreet, space-saving integration.
- Energy-Saving High-Brightness LEDs.
- PC diffuser cover for uniform soft lighting.
- Magnetic or Adhesive Mount — Easy Install.



Normal/RAL series:9002/9006/9011
Custom Colour &Finish

DMX Zigbee DALI Bluetooth APP control CAS AMBI TRIAC DIM RoHS CE

Application:

- Cabinet Lighting (functional)
- Under-Cabinet (task/ambient)
- Stair & Handrail (safety + decor)
- Ambient Accents (TV/bed/warmth)



Dimensions:

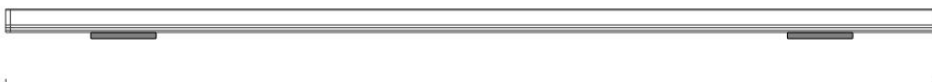

Length can be customized

Profile flexible cutting size:
L min=(1X25mm)+8=33 mm
L max=(80X25mm)+8=2008mm

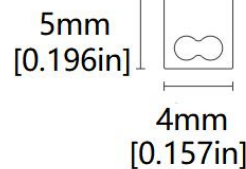

Physical

| | |
|------------------|-----------------------------|
| Housing Material | 6063 AviationGrade Aluminum |
| Lens Material | PC Opal |
| End Cap Material | PC |
| Gasket Material | / |
| Surface Finish | Silver anodised |
| Weight | / |

Electrical and Control

| | |
|-----------------------|---|
| Voltage | DC 24V |
| Wattage | MAX 8W/M |
| Control | 0-10V / DMX / DALI / ON / OFF |
| Inrush Current (Peak) | Meets NEMA-410 requirements (Based on voltage and control specifications, consult factory for details) |

Environmental

| | |
|---------------------------|--|
| Storage Temperature | -40 °C to 85 °C |
| Start-up Temperature | -40 °C to 50 °C |
| Operating Temperature | For 32.8 W/m fixtures: -40 °C to 50 °C For 72.18 W/m fixtures, CE Certification: -40 °C to 40 °C |
| Ingress Protection Rating | IP40 (No water, splash or drip protection. For use only in dry indoor environments without liquid exposure).Consult factory for details |
| Impact Resistance Rating | / |

Accessories

| | |
|--------|--------------------------------------|
| Cables | SYP Male Header SYP Female Header |
|--------|--------------------------------------|

Mounting methods

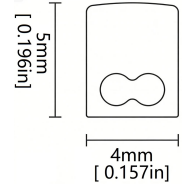
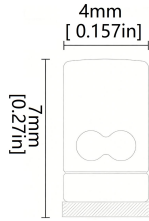
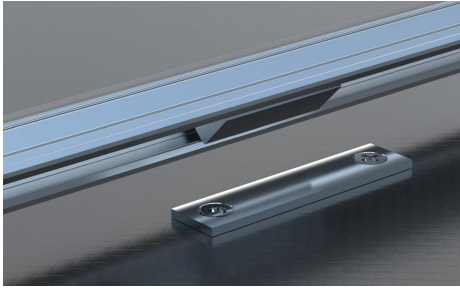

Magnet fixing (2 pcs per LED fixture)

3M Tape fixing

0/1-10V Lamp Power Supply/Dimmer Connection Description

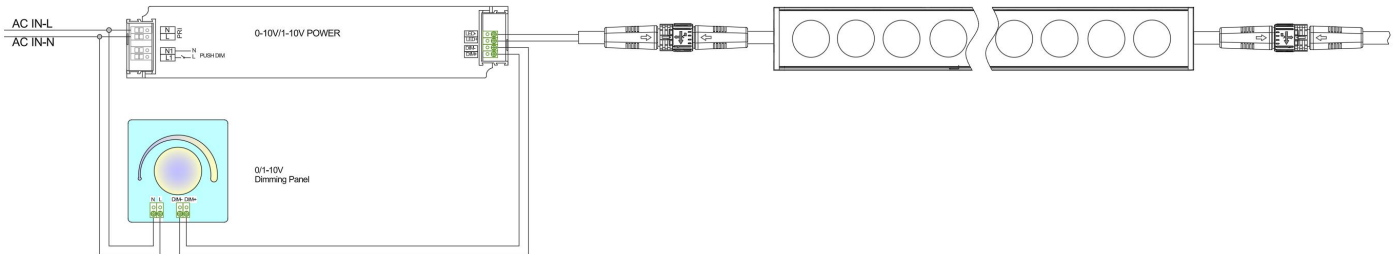

1. The signal line is separated from the power line

It is absolutely forbidden to arrange the dimming signal line (V+/-) and the AC power line (L/N) in the same conduit or trunking, nor to use the same set of multi-core cables. The electromagnetic interference of AC power supply will seriously interfere with the weak 0-10V DC signal, resulting in flickering, jitter or uneven dimming of lights.

Best practice: Using shielded twisted pair as dimming light and grounding the shielding layer at one end of the driver can effectively suppress interference.

2. Distinguish between 0-10V and 1-10V:

When buying drives and controllers, you need to confirm their specifications. They can be used together, but their behaviors are different:

1-10V controller +0-10V driver: When the dimming knob is adjusted to the lowest level, the voltage is 1V, and the lamp will not be completely turned off, and it will remain about 10% dim.

When the dimming knob is adjusted to the lowest voltage, the driver will judge that the signal is lost, and the lamp 0-10V

controller +1-10V driver: may be completely turned off or flicker.

. When designing, if "off to off" is needed, 1-10V system should be selected.

3. Load capacity and wiring distance:

The output channel of each dimming controller has the maximum load capacity (for example, the minimum load current is 0.1mA and the maximum load current is 2mA). How many drivers can a controller take depends on whether the sum of the input currents of all drivers' DIM ports can exceed the controller capacity. The signal line should not be too long, and it is recommended not to exceed 50 meters. Too long will lead to line voltage drop, so that the actual voltage reaching the driver is lower than the output voltage of the controller, which will affect the dimming consistency.

4. Common ground problem

In some complex systems, if the DIM- terminal potentials of multiple drivers are inconsistent, it may cause interference. This problem can be avoided by ensuring that all signal loops use the dimming controller with isolation function well.

5. Power-on sequence:

The system should follow the correct power-on sequence: first turn on the main power supply, so that the driver and controller can get power, and then perform dimming operation. A sudden full voltage signal may impact the driver.

6. Compatibility and testing:

Different brands of drives and controllers may have subtle compatibility problems. Before the installation of large-scale projects, samples must be tested and inspected. Prove the smoothness, minimum brightness and flicker of dimming curve.

Wiring diagram of DALI digital lighting system

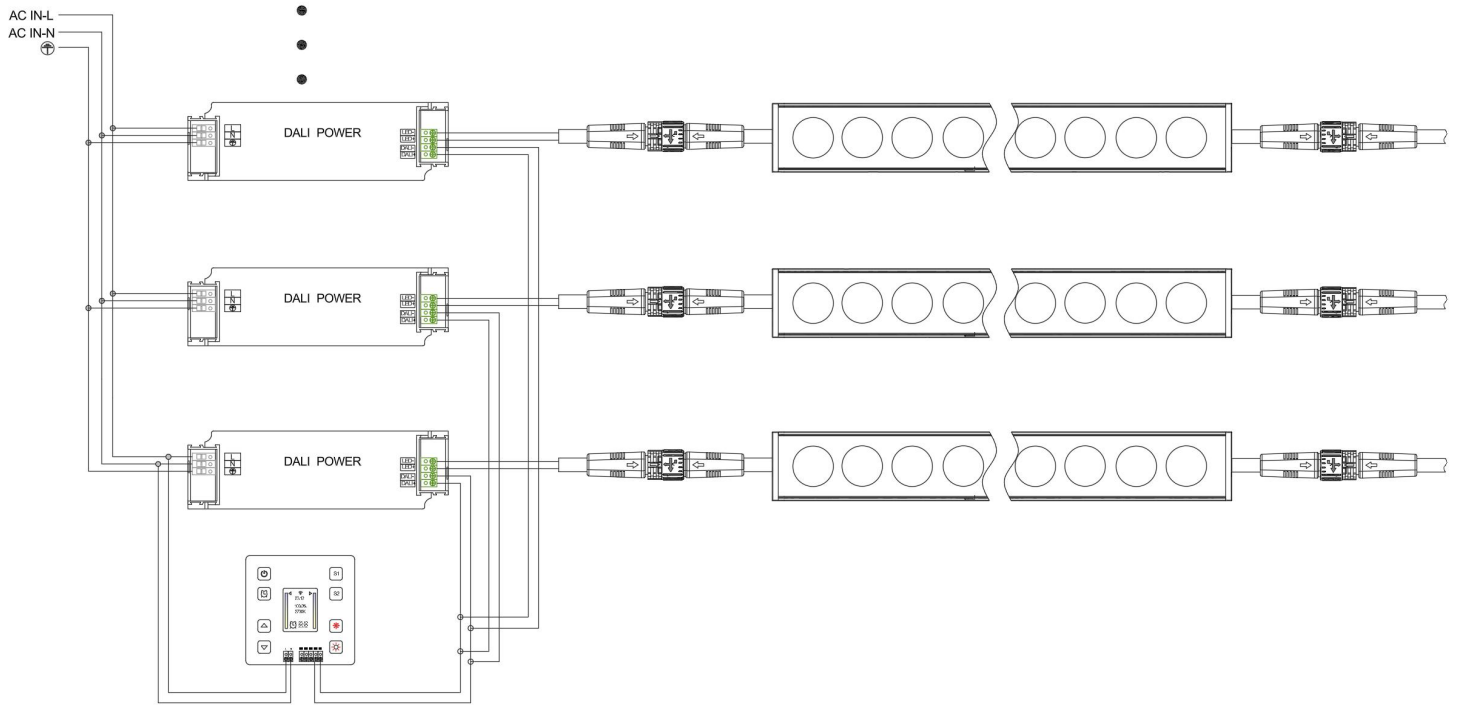

1. Laying bus: use twisted pair to connect DALI+ and DALI- terminals of all equipment (well connection).
2. Connect the power supply: Connect the only DALI system power supply to the bus.
3. Access control: connect the controller, panel and sensor to the bus.
4. Connect the driver with the load: connect the AC power supply (L,N) and DALI bus for each driver, and connect the lamps with its output.
5. Power-on debugging: Use DALI debugging software to allocate short url for each device, and group and set the scene.