

Model No : CA71D26.11

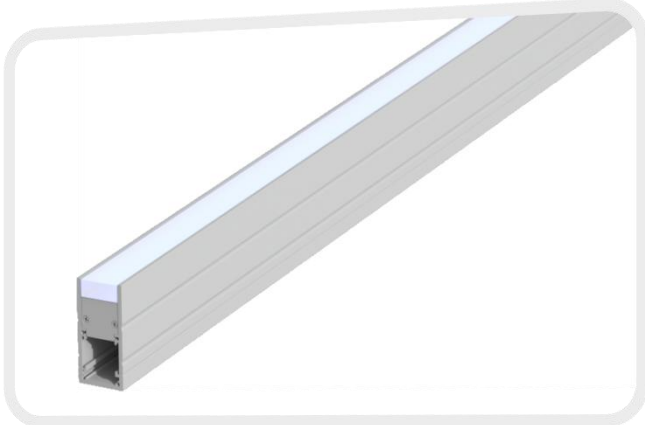

Features:

- 30mm ultra-narrow design for seamless integration.
- Exceptional uniformity with integrated Anti-UV acrylic.
- Smooth dynamic effects via RGBW+DMX control.
- IP67 rating for durability in harsh environments.



Normal/RAL series:9002/9006/9011
Custom Colour &Finish



Application:

- It's widely used as a decorative lights, and use it as the lights;
- Stage decoration, festival, exhibition, wedding;
- Backlight of signage, channel letters lighting;
- Landscape layout lighting;

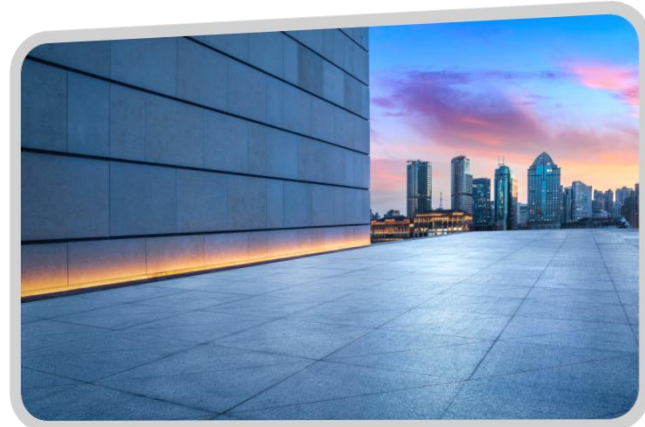

Dimensions:

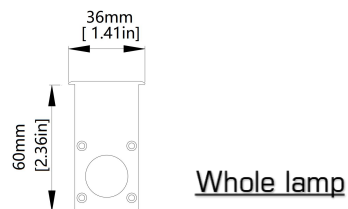
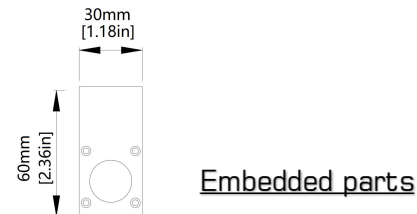
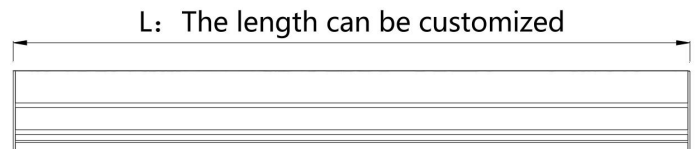
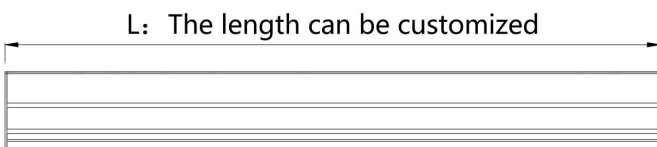
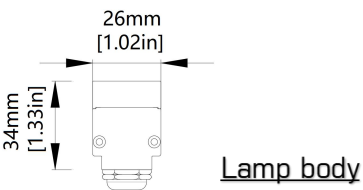
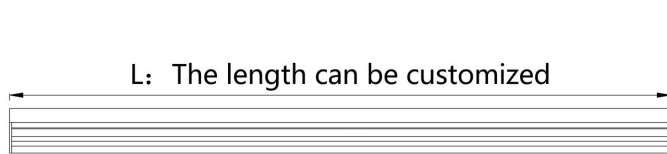

Physical

Housing Material	6063 high-density aluminum
Lens Material	PMMA
End Cap Material	Die cast aluminium
Gasket Material	Silicone
Surface Finish	primer and electrostatically-applied, powder coat paint finish
Weight	/

Electrical and Control

Voltage	DC 24V
Wattage	Max 24W/M
Control	0-10V / DMX / DALI / ON / OFF
Inrush Current (Peak)	Meets NEMA-410 requirements (Based on voltage and control specifications, consult factory for details)

Environmental

Storage Temperature	-40 °C to 85 °C
Start-up Temperature	-40 °C to 50 °C
Operating Temperature	For 32.8 W/m fixtures: -40 °C to 50 °C For 72.18 W/m fixtures, CE Certification: -40 °C to 40 °C
Ingress Protection Rating	IP67 (suitable for applications with temporary immersion in water only (no permanent immersion), proper drainage around the fixture is required). Consult factory for details
Impact Resistance Rating	IK08 (Consult factory for IK08 lens option)

Accessories (Order Separately)

Cables	Lumenfacade Leader Cable Lumenfacade Jumper Cable Lumenfacade T-Junction
--------	--

Mounting Method

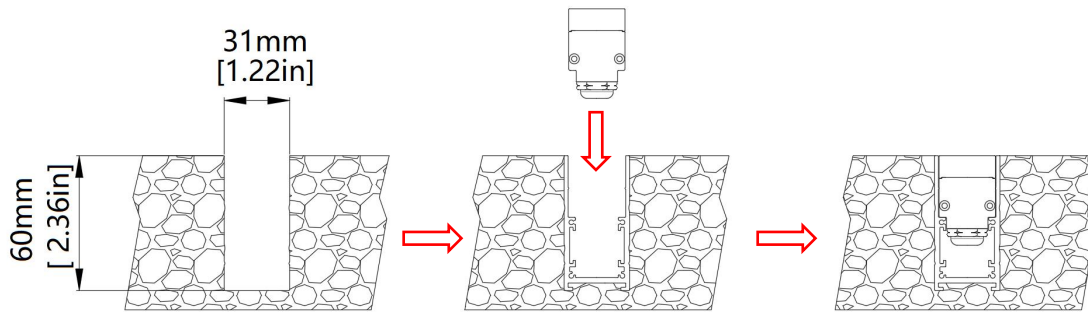

①

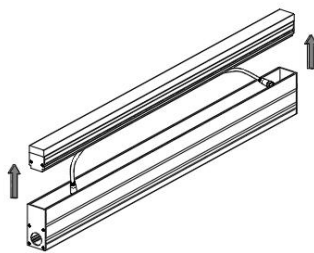

1. Slowly take out the lamp body vertically upward. Avoid pulling and bending the connecting cable.
2. Immediately after taking it out, use waterproof tape or special protective cover to tightly wrap the power interface of lamps and lanterns and the terminals in the embedded parts, respectively, to prevent dust and water.

②

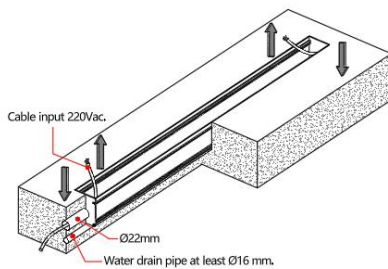

1. Trench excavation: excavate the trench according to the size of embedded parts to ensure that the trench bottom is flat and level.
2. Installation of embedded parts: put the embedded parts into the groove and fix them with concrete. This is the "foundation" of lamps and lanterns, which must be firm and level to prevent water accumulation and uneven stress.
3. Laying conduit: wire sleeve shall be embedded, and the maintenance line length of 30-50 cm shall be reserved in the conduit.
4. Active drainage: In areas with high water level or heavy rainfall, it is necessary to set a drainage pipe with a diameter greater than 16mm at the lowest point of embedded parts to prevent internal water accumulation.

③

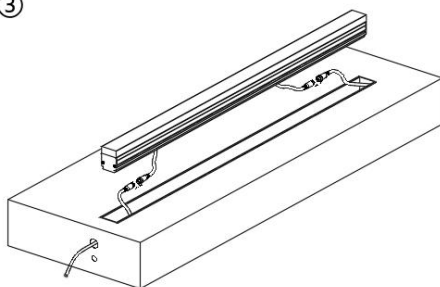

1. Power-off check: make sure that the main power supply has been disconnected and verify it with an electric pen.
2. Prepare materials: waterproof junction box (IP68), waterproof power cord, terminal, sealant, installation tools, etc. Lay the power cord through the pipe next to each embedded part, and reserve a 15cm thread head in the junction box.
3. Connection: Connect the lamp cable and power cord reliably in the waterproof junction box through connectors or copper terminals.
4. Turn on the power supply and test whether all lamps and lanterns are lit normally and whether the dimming/color changing function (if any) is normal.

⚠ WARNINGS

Switch off mains power supply before joining the connectors

④

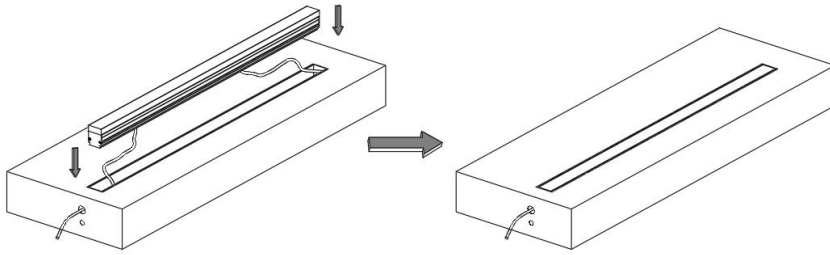

1. After the electrical connection is completed, put the cable into the box.
2. Carefully install the lamp into the installation box to ensure that the cable will not get stuck.

Precautions for installation of embedded parts

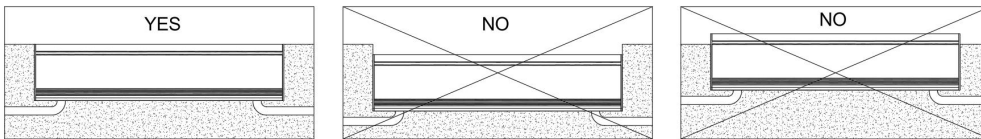

Note: When fixing the embedded parts, besides being horizontal, it is also necessary to ensure that the height of the upper edge of the embedded parts is exactly the same as that of the final finished surface to avoid unevenness after installation.

Fixture Spacing and Cable Management

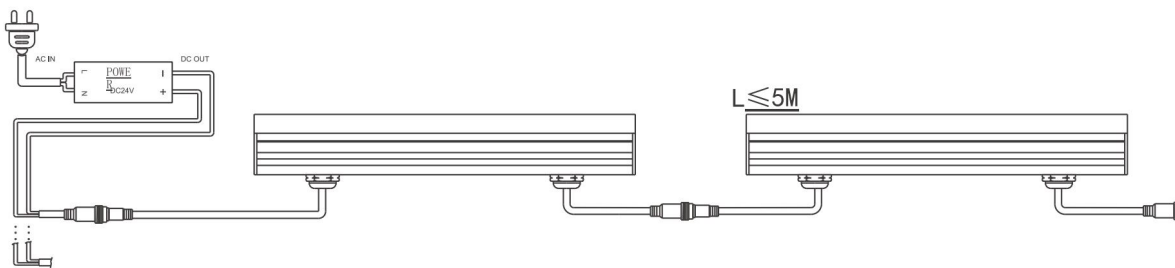

Each set of line strips has a maximum length of 5 meters
Please ensure that it is carried out in case of power failure during installation and maintenance.

Description of power supply/controller connection of DMX512 lamps (lamps with built-in 512 chips)

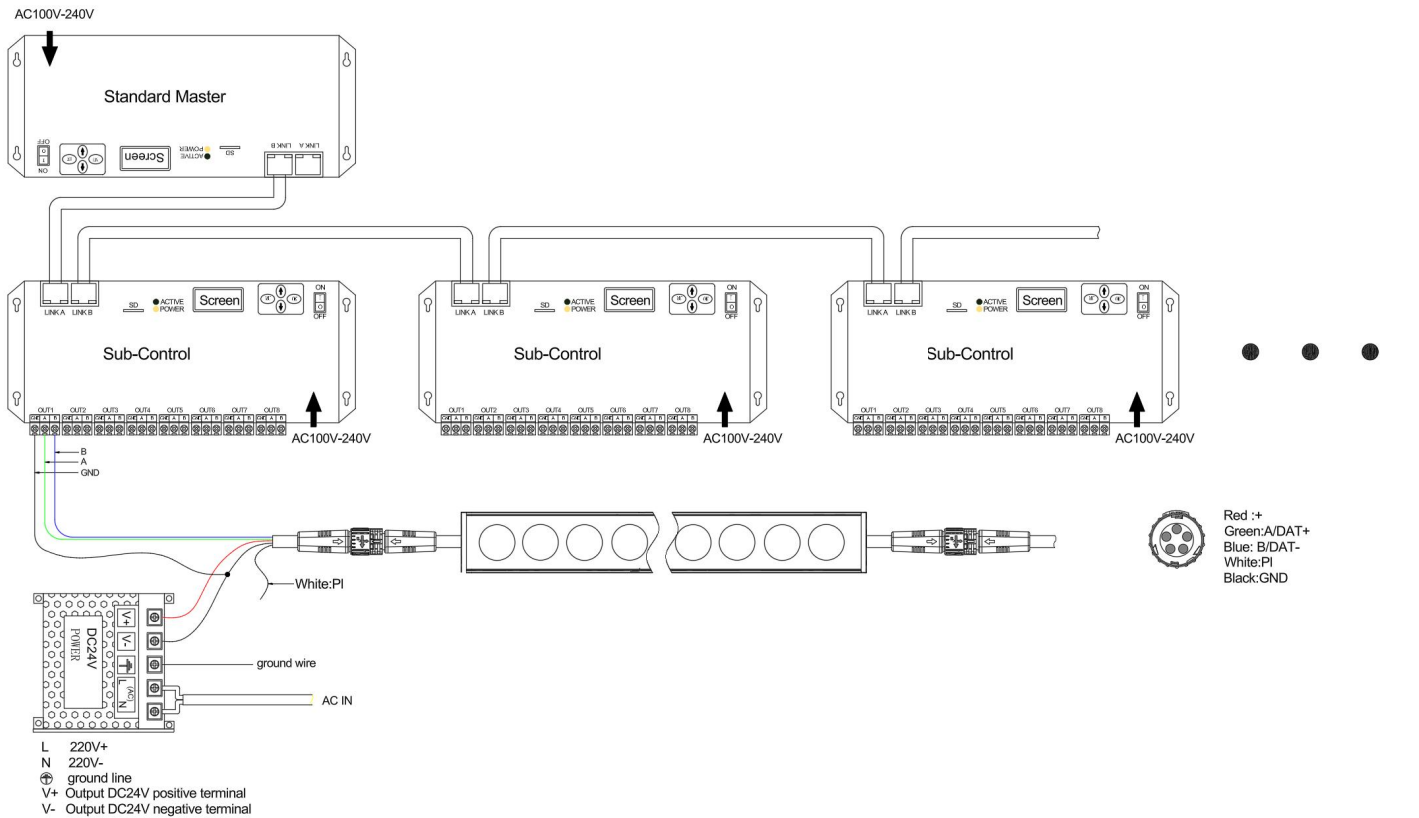

(orange wire is A, orange white wire is B, and other 6-core wires are GND) from the sub-control output port to the first lamp, and the distance between the wires shall not exceed 80m (if it exceeds 80m, it needs to be added.

Signal amplifier, which needs additional configuration);

3. Description of the signal connection line between the sub-control and lamps: The white line is signal A; The blue line is signal b; The black line is GND (code-writing green line is forbidden to access the controller);

4. The divided control output GND is connected in parallel with the negative pole of the switching power supply (view);

5. Each port of the sub-control output can only have 256 pixels at most (if 10 points are calculated at 1 meter, the signal lines are connected in series for 20 meters);

6. Reference for switching power supply load connection: Take 350W switching power supply as an example, each power supply load is 20m at most, and it is divided into two groups of main lines (each branch is 5m in series at most).

7. The wire of the lamp connector is 5 cores, and the wiring color of 24V power supply is: the red wire is 24V positive electrode, and the black wire is 24V negative electrode (GND);

8. The power supply at the input of the sub-control equipment is AC220V, and the input terminal voltage of the switching power supply equipment is AC220V. It is required that the AC 220 V of these two kinds of equipment are supplied on the same circuit, that is, they need to be supplied at the same time;

9. The male head (with pins) of lamps and lanterns is the signal input and the female head is the signal output. Please connect the lamps and lanterns in sequence, otherwise it cannot be coded;

10.wiring need power operation, so as not to damage the lamps and lanterns; If you have any questions during wiring installation, please contact our company in time after sale!

11. All lamps and lanterns are installed and checked before being powered on, and the lamps and lanterns are coded after being powered on.

0/1-10V Lamp Power Supply/Dimmer Connection Description

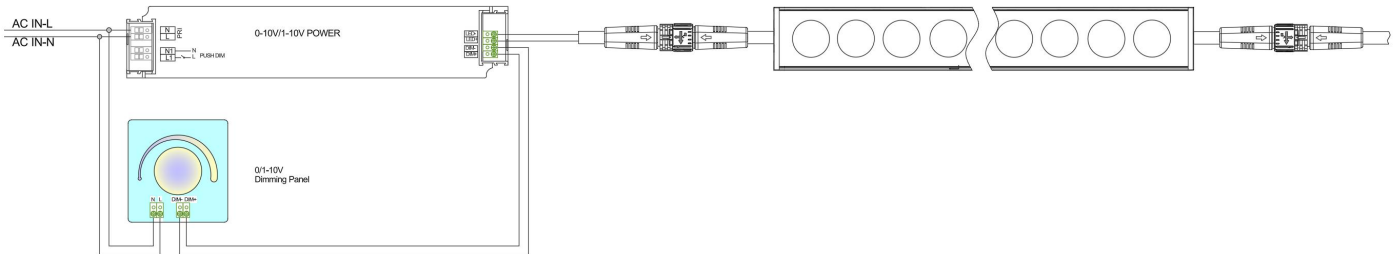

1. The signal line is separated from the power line

It is absolutely forbidden to arrange the dimming signal line (V+/-) and the AC power line (L/N) in the same conduit or trunking, nor to use the same set of multi-core cables. The electromagnetic interference of AC power supply will seriously interfere with the weak 0-10V DC signal, resulting in flickering, jitter or uneven dimming of lights.

Best practice: Using shielded twisted pair as dimming light and grounding the shielding layer at one end of the driver can effectively suppress interference.

2. Distinguish between 0-10V and 1-10V:

When buying drives and controllers, you need to confirm their specifications. They can be used together, but their behaviors are different:

1-10V controller +0-10V driver: When the dimming knob is adjusted to the lowest level, the voltage is 1V, and the lamp will not be completely turned off, and it will remain about 10% dim.

When the dimming knob is adjusted to the lowest voltage, the driver will judge that the signal is lost, and the lamp 0-10V

controller +1-10V driver: may be completely turned off or flicker.

. When designing, if "off to off" is needed, 1-10V system should be selected.

3. Load capacity and wiring distance:

The output channel of each dimming controller has the maximum load capacity (for example, the minimum load current is 0.1mA and the maximum load current is 2mA). How many drivers can a controller take depends on whether the sum of the input currents of all drivers' DIM ports can exceed the controller capacity. The signal line should not be too long, and it is recommended not to exceed 50 meters. Too long will lead to line voltage drop, so that the actual voltage reaching the driver is lower than the output voltage of the controller, which will affect the dimming consistency.

4. Common ground problem

In some complex systems, if the DIM- terminal potentials of multiple drivers are inconsistent, it may cause interference. This problem can be avoided by ensuring that all signal loops use the dimming controller with isolation function well.

5. Power-on sequence:

The system should follow the correct power-on sequence: first turn on the main power supply, so that the driver and controller can get power, and then perform dimming operation. A sudden full voltage signal may impact the driver.

6. Compatibility and testing:

Different brands of drives and controllers may have subtle compatibility problems. Before the installation of large-scale projects, samples must be tested and inspected. Prove the smoothness, minimum brightness and flicker of dimming curve.

Wiring diagram of DALI digital lighting system

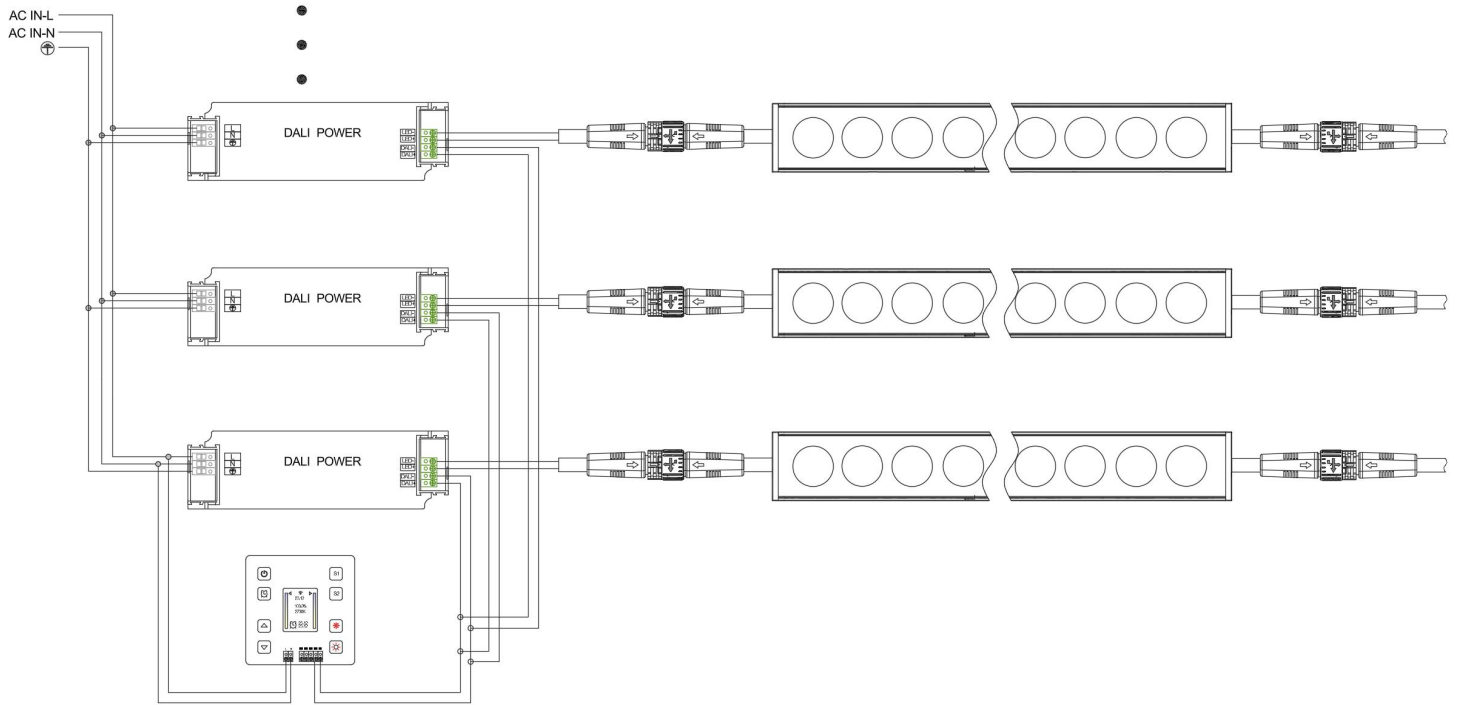

1. Laying bus: use twisted pair to connect DALI+ and DALI- terminals of all equipment (well connection).
2. Connect the power supply: Connect the only DALI system power supply to the bus.
3. Access control: connect the controller, panel and sensor to the bus.
4. Connect the driver with the load: connect the AC power supply (L,N) and DALI bus for each driver, and connect the lamps with its output.
5. Power-on debugging: Use DALI debugging software to allocate short url for each device, and group and set the scene.